

SORAA aerial™

CYLINDER 65mm 220-240VAC



Output	Color & Optics	Mounting
Lumens 505-1017	CCT 2700K, 3000K, 4000K	Surface Pendant
CBCP 2347-8090	CRI 95	Recessed Pendant
	R9 >95	Track Pendant
	Rw 100	
	SDCM 3-step McA nominal	

Operation	Electrical
Efficacy 47-57 lm/W	Input Voltage 220-240VAC
Ambient Operating Temp. Minimum -40°C, 25°C typical	Input Current 0.08A
Lifetime L70/B50=25,000 hrs	Frequency 50/60Hz
Warranty 5 years	Power Factor 0.93
	Wattage 11W, 17W, 18W
	Dimming to 1%



SORAA VIVID™ LED & SORAA OPTICS

Soraa Full Spectrum 95CRI, 95R9 integral LED Light Engine. Soraa optics technology with exceptional beam control and smooth uniform light distribution. The 10° and 15° beam versions are compatible with Soraa SNAP accessories.

CONSTRUCTION & FINISH

Light engine is made of die cast aluminium, cylinder case from extruded aluminum. Durable matte finish. Custom finish combinations and colors available. Bezel with light engine is replaceable.

APPLICATIONS

For interior use only. Suitable for installation in any ceiling type.

INSTALLATION

Surface mounting for electrical connection in canopy/junction box on ceiling surface. Recessed mounting for electrical connection in ceiling. Track mounting available for various track types. Luminaire to be fixed to ceiling with screws and screw anchors (by others). Optional canopy accessory available for installation on exposed ceiling with conduits. Braided sleeve cable supplied with standard length of 175 cm.

ELECTRICAL & DIMMING

220-240VAC integrated electronic constant current LED driver included. Dimmable to <1%. DALI, 0-10V, Triac and ELV dimming standard.

COMPLIANCE

CE compliant. IP20 rated.

Recessed Mount Option

Sample Track Mount Option

Optional Canopy Accessory

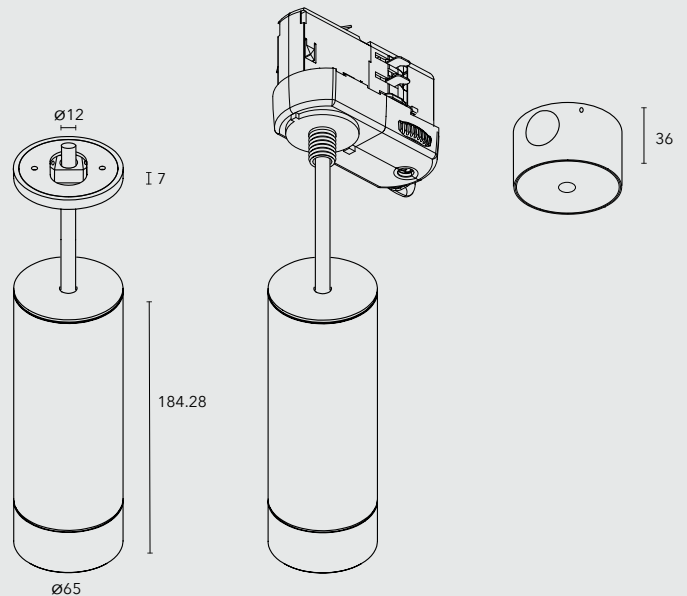

SORAA®
SIMPLY PERFECT LIGHT

LUMINAIRE Sample Number: ALP65 -10D - 9530 - U - T - BBZ - CB - G - S3

Series	Aperture	Beam & Wattage	CRI/CCT	Driver	Mounting
ALP Soraa Aerial Pendant Mount	65 65mm	10D 10° Narrow Spot 11W 15D 15° Narrow Spot 17W 25D 25° Narrow Flood 18W 36D 36° Flood 18W	9527 95/2700K 9530 95/3000K 9540 95/4000K	E 220-240 Phase dim ED 220-240 DALI E10 220-240 0-10V	S Surface R Recessed/Inline T Track

Body, Bezel, Cable and Canopy may be ordered in different colors

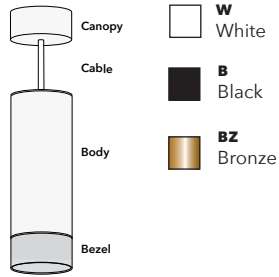

Color (Body/Bezel)

BB	Black/Black
BW	Black/White
BBZ	Black/Bronze
WB	White/Black
WW	White/White
WBZ	White/Bronze
BZB	Bronze/Black
BZW	Bronze/White
BZBZ	Bronze/Bronze
CC	Custom/Custom

Cable

CB	Black
CW	White
CX	Custom

Track Adapter * (with track mount option)

G	Global 3-circuit 3C1N Nordic GA69
GC	Global 3-circuit+data 3C1N+D Nordic GAC69
EUF	Eutrac 3-circuit (flushed) EUTRAC 555-1-6533-X
EUF D	Eutrac 3-circuit+data (flushed) EUTRAC 555-2-6533-X
GE	Erco+Dali

Region

S3	EU
-----------	----

* Track adapter color is black when ordered with black or bronze luminaire body color, white when ordered with white body color

OPTIONAL ACCESSORIES Sample Number: ALA - C - K - BZ



Series

ALA	Aerial Accessory
------------	------------------

Note: use canopy accessory with Surface Mount luminaire (S) only

Type

C	Canopy/Junction Box
----------	---------------------

Knockout

K	With Knockouts
----------	----------------

Color

B	Black
W	White
BZ	Bronze
C	Custom

SORAA VIVID™ COLOR & WHITENESS RENDERING

CCT	CRI	R9	Rf	Rg	Rfh1	Rw	McA
2700	95	95	90	100	95	120	3
3000	95	95	90	100	95	120	3
4000	95	95	90	100	95	70	4

Rf: The TM-30 metric for color fidelity (similarity to colors under natural light), a more accurate version of the CRI Ra. Rf is 100 for natural light.

Rg: The TM-30 metric for color gamut (whether colors are more saturated than under natural light). Rg is 100 for natural light.

Rfh1: The TM-30 metric for color fidelity for red tones. Rfh1 is a more accurate version of the CRI R9. Rfh1 is 100 for natural light.

Rw: The Soraa-developed metric for white fidelity. Rw measures the magnitude of excitation of whitening agents within white materials. Rw is 100 for natural light.

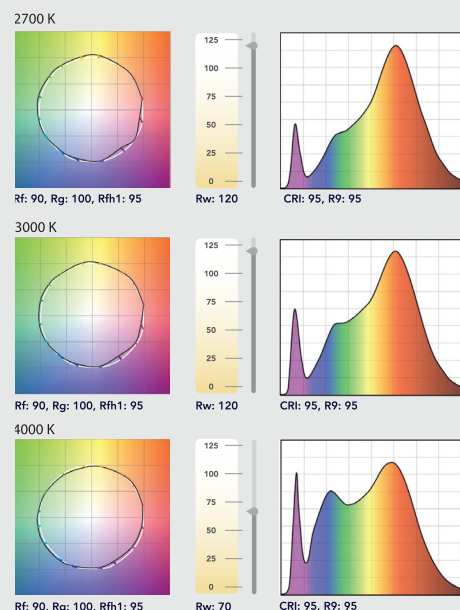

PHOTOMETRICS

Narrow Spot 10°

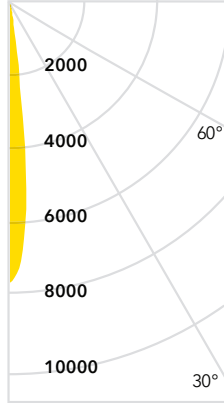

Spot 15°

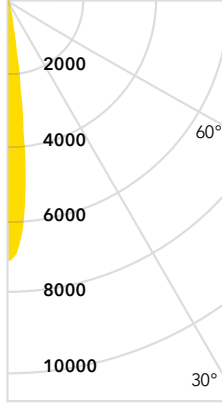

Narrow Flood 25°

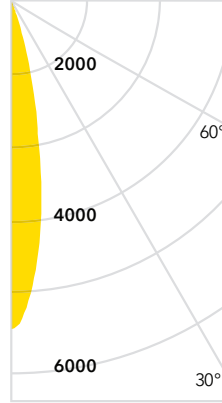

Flood 36°

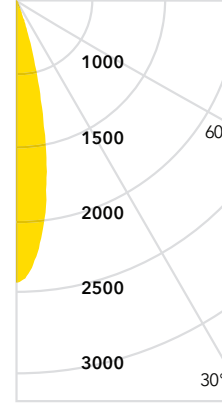

Data is shown for 3000K, for 2700K multiply Lux by 0.95, for 4000K by 1.04.

W	CCT	Lm	CBCP
11	2700	505	7360 cd
11	3000	535	7800 cd
11	4000	555	8090 cd

W	CCT	Lm	CBCP
17	2700	802	6622 cd
17	3000	848	6994 cd
17	4000	880	7254 cd

W	CCT	Lm	CBCP
18	2700	929	5052 cd
18	3000	978	5318 cd
18	4000	1017	5529 cd

W	CCT	Lm	CBCP
18	2700	929	2347 cd
18	3000	978	2476 cd
18	4000	1017	2567 cd

Candelas at Nadir

0°	8139
5°	5415
15°	248
25°	91
35°	54
45°	25

Candelas at Nadir

0°	6994
5°	6074
15°	500
25°	184
35°	73
45°	48

Candelas at Nadir

0°	5318
5°	4495
15°	1485
25°	164
35°	47
45°	24

Candelas at Nadir

0°	2510
5°	2427
15°	1547
25°	523
35°	104
45°	31

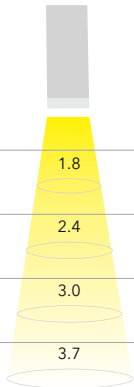

Beam	Field	LX
1.8	0.4	2400
2.4	0.5	1367
3.0	0.6	883
3.7	0.8	624

Beam	Field	LX
0.5	1.0	2433
0.6	1.2	1367
0.8	1.6	883
0.9	2.0	614

Beam	Field	LX
0.7	1.4	1765
0.9	2.0	1001
1.1	2.2	657
1.3	2.6	463

Beam	Field	LX
1.0	2.0	840
1.3	2.6	484
1.6	3.2	312
1.9	3.8	226

Beam=Dia at 50% CBCP (Metres)

Field = Dia at 10% CBCP (Metres)

LX= Lux