



SORAA arc™

arc



SORAA ARC™ IS THE SYNTHESIS OF PERFECT LIGHT AND INSPIRED DESIGN.

STUNNING FORM FOLLOWS REMARKABLE FUNCTION IN FIXTURES ENGINEERED AROUND AN ULTRA THIN PROFILE DIE-CAST HEAT SINK. OPTIMISED FOR SUPERIOR THERMAL MANAGEMENT AND ENDOWED WITH SORAA'S SIGNATURE QUALITY OF LIGHT, THEY FEATURE RICH COLOURS, PERFECTLY RENDERED WHITES, AND CLEAN, CRISP BEAMS. FOR A WIDE RANGE OF APPLICATIONS, THIS IS LIGHTING AT THE TOP OF THE CURVE.



DESIGNED FROM THE INSIDE OUT.

CONTENTS

4	APPLICATIONS
8	ARC SERIES
10	TRACK ART
12	PENDANT ARP
14	ADJUSTABLE ARA
16	DOWNLIGHT
18	SNAP SYSTEM
22	LIGHT SPECIFICATIONS

MUSEUMS



Soraa Arc features Soraa VIVID Color™ and Soraa Natural White™ rendering both colours and whites naturally and perfectly, ideal for settings and applications that demand accuracy and ultra-clear differentiation.



arc

HOSPITALITY



Soraa Arc gives you the ability to set the mood. Crisp, clean, point source optics, and Snap System compatibility give you complete control over the beam, colour, and intensity to create truly inviting environments.

arc

RETAIL



When colours are richer and shadows are cleaner, products on display come into their own. Soraa's broader visible spectrum, R9, and infinite shades of white help to present merchandise in the right light.

arc

RESIDENTIAL



At home, Soraa Arc is lighting that is meant to be seen. In addition to its legendary Soraa VIVID™ colour quality, ARC stands on its own, adding to the art and architecture of a beautiful environment.



SORAA arc™ SERIES



ART 50mm



ART 100mm

TRACK



ARP 50mm



ARP 100mm

PENDANT



ARA 50mm
Semi-Recessed
Mount



ARA 50mm
Recessed Mount



ARA 100mm
Semi-Recessed
Mount



ARA 100mm
Recessed Mount

ADJUSTABLE



Square Trimmed



Square Trimless



Square Trim



Square Trim



Round Trimmed



Round Trimless



Round Trim



Round Trim



50mm Snout



100mm Snout



50mm Wall Wash



100mm Wall Wash



Clear



Beam Shaping



Enhance



Aim



CCT Shifter



Louver

DOWNLIGHT

50mm 3-in-1 featuring fixed, wall wash, and adjustable positions

ACCESSORIES

Ideal for museums, retail display



TRACK

SORAA arc™ TRACK

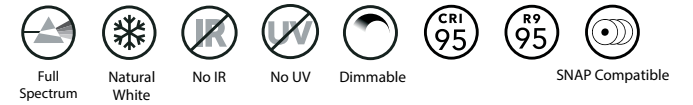

ORDERING GUIDE

Product SKU	Beam & Wattage	CCT	Driver	Track Compatibility	Finish	CBCP (cd)	Lumens
ART50 Soraa Arc Track, 50mm	10D 10° Narrow Spot - 11W ☺	927 2700K	E 220-240VAC Phase Dim	G 3 circuit G1 1 circuit (other adapters available)	B Black W White S Silver C Custom	7800	535
	15D 15° Narrow Spot - 18W ☺	930 3000K					930
	25D 25° Narrow Flood - 18W	940 4000K					1000
	36D 36° Flood - 18W						1000
ART100 Soraa Arc Track, 100mm	09D 9° Narrow Spot - 20W ☺					18500	1000
	25D 25° Narrow Flood - 20W					6090	1050
	36D 36° Flood - 20W					2830	1050

(Typical for 3000K)

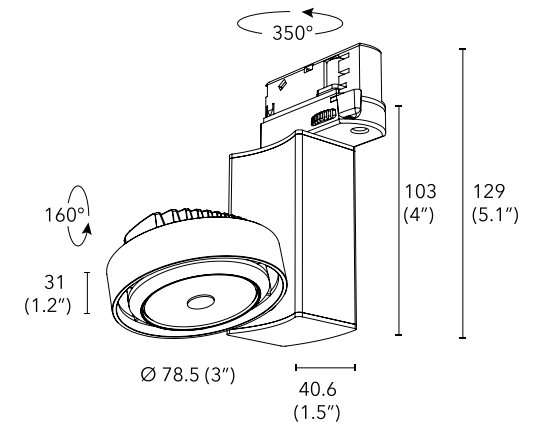
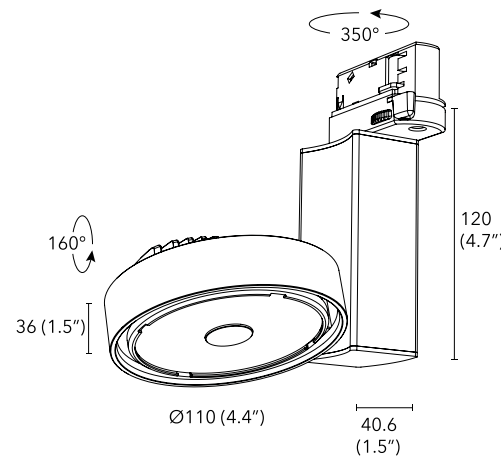
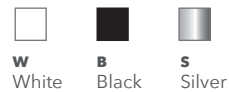

PENDANT



SORAA arc™ PENDANT



ORDERING GUIDE

Product SKU	Beam & Wattage	CCT	Driver	Mounting	Finish	CBCP (cd)	Lumens
ARP50 Soraa Arc Pendant, 50mm	10D 10° Narrow Spot - 11W ☺	927 2700K	E 220-240VAC Phase Dim	SR Semi Recessed	B Black W White S Silver C Custom	7800	535
	15D 15° Narrow Spot - 18W ☺	930 3000K					930
	25D 25° Narrow Flood - 18W	940 4000K					1000
	36D 36° Flood - 18W						1000
ARP100 Soraa Arc Pendant, 100mm	09D 9° Narrow Spot ☺					18500	950
	25D 25° Narrow Flood					6090	1050
	36D 36° Flood					2830	1050
	60D 60° Wide Flood					1150	1050

(Typical for 3000K)



Pendant furnished with 1981mm /side of coated electrical cable, fully adjustable lengths.

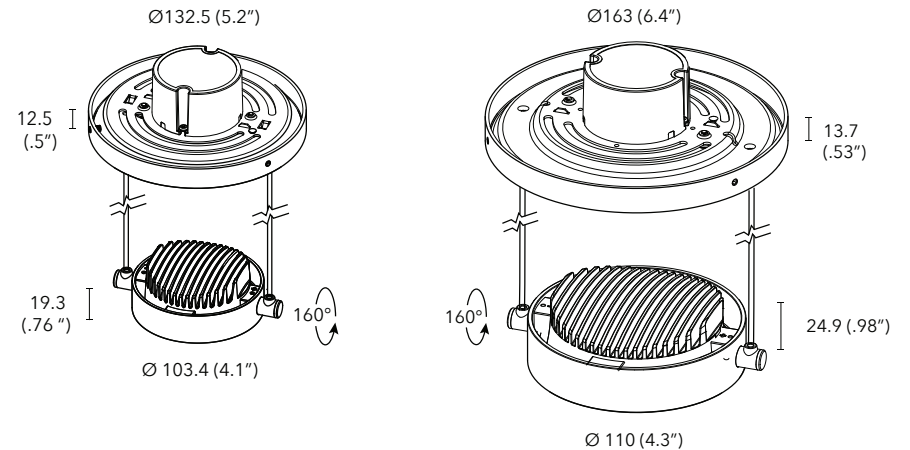



ADJUSTABLE

SORAA arc™ ADJUSTABLE

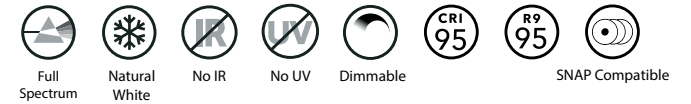

ORDERING GUIDE

Product SKU	Beam & Wattage	CCT	Driver	Mounting	Finish	CBCP (cd)	Lumens
ARA50 Soraa Arc Adjustable, 50mm	10D 10° Narrow Spot - 11W	927 2700K	E 220-240VAC Phase Dim	SR Semi Recessed R Recessed	B Black	7800	535
	15D 15° Narrow Spot - 18W	930 3000K			W White	8080	930
	25D 25° Narrow Flood - 18W	940 4000K			S Silver	5800	1000
	36D 36° Flood - 18W				C Custom	2700	1000
ARA100 Soraa Arc Adjustable, 100mm	09D 9° Narrow Spot - 20W					18500	1000
	25D 25° Narrow Flood - 20W					6090	1050
	36D 36° Flood - 20W					2830	1050
	60D 60° Wide Flood - 20W					1150	1050

(Typical for 3000K)

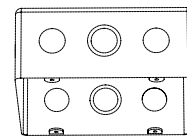

6" Junction box
(Not Included)

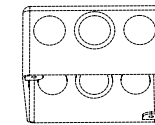

4" Junction box
(Not Included)

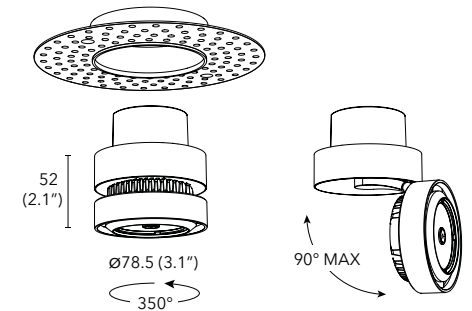
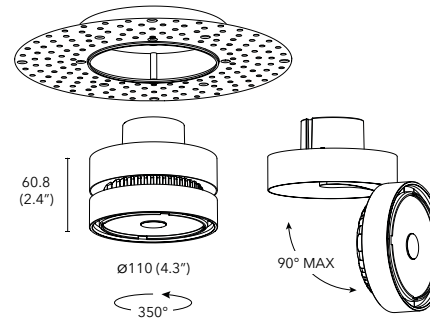

DOWNLIGHT

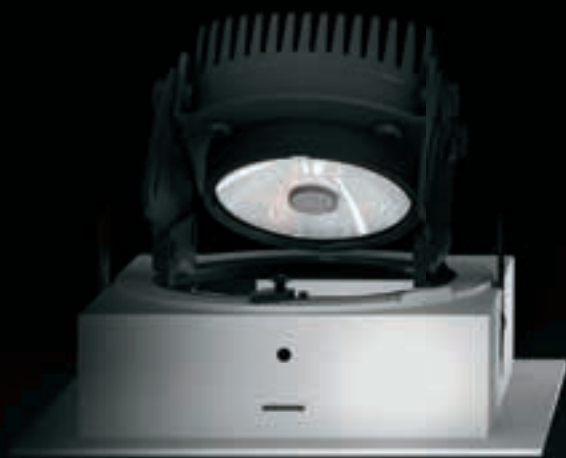

SORAA arc™ DOWNLIGHT

50mm 3-in-1 featuring fixed, wall wash, and adjustable positions

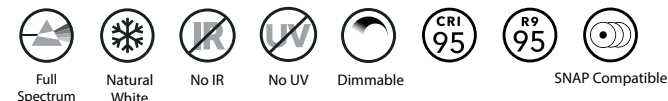

ORDERING GUIDE

Step 1 Choose your Installation application

Drivers (EU)

DD50 Driver Kit (EU), 50mm
DRD Remodel Driver

IC Rating

IC IC Rated
T Thermally Protected Non-IC

Voltage

E 220-240 Phase Dim
ED 230V DALI
Specify Other

Emergency Backup

EMR Emergency (Non-IC Only)

Step 2 Choose your light experience

Light Engine

DER50 Soraarc Arc Downlight Round, 50mm
DES50 Soraarc Arc Downlight Square, 50mm

Beam & Wattage

10D 10° Narrow Spot - 11W ☺
15D 15° Narrow Spot - 18W ☺
25D 25° Narrow Flood - 18W
36D 36° Flood - 18W

CCT

927 2700K
930 3000K
940 4000K

Mounting

F Frame Kit
R Remodel

Trim Style

T Trimmed
TL Trimless

Finish

B Black
W White
S Silver
C Custom

CBCP (cd)

7800
8080
5800
2700

Lumens

535
930
1000
1000

(Typical for 3000K)

Step 3 Choose your finished look with a SNAP trim

Trims

DTS50 Square Downlight, 50mm
RTSW50 Square Wall Wash, 50mm
DTR50 Round Downlight, 50mm
RTW50 Round Wall Wash, 50mm

Width

TW 12.7mm (1/2") Trim
TF 3.2mm (1/8") Flange

Finish

B Black
W White
S Silver
T Tangerine
C Custom

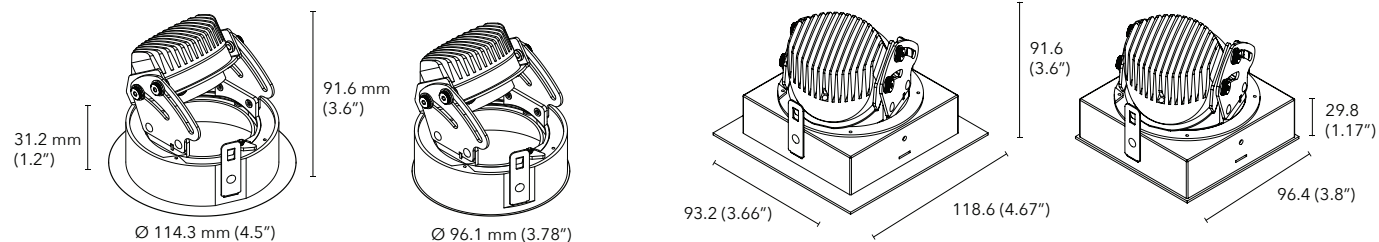

They fit your
light style.

ARC is universally compatible with
the Sora Snap System,[™] giving you
total control to colour and sculpt
the perfect light.



Snap

SORAA snap system™

Soraa Arc in 9°, 10°, and 15° beams are designed to work with the Soraa Snap System™ creating an optimised solution for luminaires and integrated lamp accessories.

Coupled with Soraa's high brightness single source LED technology, Soraa Snap System lighting effects are similar to halogen sources, with the added benefits of low operating temperature, ground-breaking optical design, and method of attachment.

The self-centering magnetic system is simple. Place a SNAP accessory directly on an Arc surface and the magnetic force will do the rest.

Soraa Snaps can be used in combination with other Soraa Arc accessories, They can be stacked (i.e. beam spreader and a CCT shifter) or when combining beam shaping Snaps with CCT shifters,

Soraa Snaps are only compatible with Soraa Arc luminaires, Soraa lamps, and Optical Light Engines, in 9°, 10°, and 15° beam versions. See individual SNAP accessory data for exact diameters.

IES files and photometric data for SNAP accessories are available at www.soraa.com.

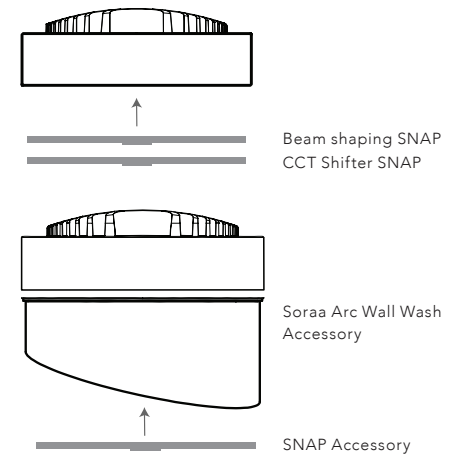

For best results always place CCT shifting Snap on the lamp first

Clear

Use together with gel and dichroic filters for total colour freedom. Produce the exact mood and effect you want for any environment. Sold in quantities of ten.

Diameter	Part Number	Product Code	Lumen Transmission (1 Snap)	Lumen Transmission (2 Snaps)	Thickness	Magnetic Attach Force
50mm	AC-CL-0000-00	02183	93%	87%	2mm	0.45 lb-F
84mm	AC-E-CL-0000-00	02185	93%	87%	3.1mm	

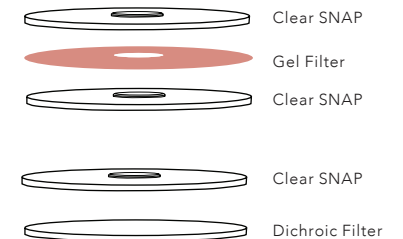

Suggested use with Gel or Dichroic filters

Enhance

A colour enhancing filter designed to modify the spectrum of Soraa VIVID luminaires and increase the vividness of warm colours (red, orange and pink) and greens. Use Enhance in applications where even richer, more vibrant colour is desired.

Diameter	Part Number	Product Code	Lumen Transmission	Whiteness	Thickness	Magnetic Attach Force
50mm	AC-EN-0001-00	03281	75%	130%	2mm	0.45 lb-F
84mm	AC-E-EN-0001-00	03283	75%	130%	2mm	

Application Notes:

Use with CCTs of 3000K and 2700K.
Combine with either a Louver Snap (for 10° spot applications) or with a Beam Spreader Snap (for other beam angles)
Place Enhance as the first filter when stacking with other Snap accessories.



Soraa Vivid (2700K & 3000K)
Rf:90, Rg:100,
Rw (Whiteness): 120

With Enhance Snap
Rf:75, Rg:112
Rw (Whiteness): 130

SORAA snap system™

Beam Spreader

Use in any application where reducing the number of beam angle SKUs is required. Reduces inventory costs, shortens specification, design, and sales cycles. Provides maximum flexibility up to the time of installation.

Diameter	Beam	Part Number	Product Code	CBCP of 10°, 9° Beam	Field Angle	Lumen Transmission	Thickness	Magnetic Attach Force
50mm	17°	AC-GC-1717-00	03263	30%	33°	90%	2mm	0.45 lb-F
	25°	AC-GC-2525-00	00325	29%	40°			
	36°	AC-GC-3636-00	00327	14%	55°			
84mm	60°	AC-GC-6060-00	00329	5%	103°		3.1mm	
	17°	AC-E-GC-1717-00	03265	53%	33°			
	25°	AC-E-GC-2525-00	01145	18%	40°			
	36°	AC-E-GC-3636-00	01147	8%	55°			
	60°	AC-E-GC-6060-00	01149	3%	90°			

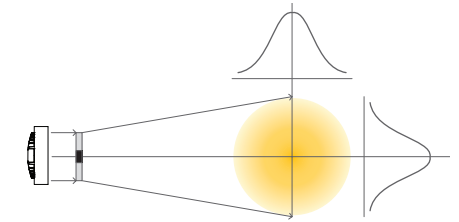
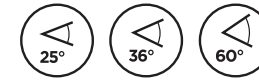

Linear

Use in wall washes and illuminating asymmetric objects. Reduces required number of light fixtures and spill illumination of target objects.

Diameter	Beam	Part Number	Product Code	CBCP of 10°, 9° Beam	Field Angle Horiz/Vert	Lumen Transmission	Thickness	Magnetic Attach Force
50mm	10-25°	AC-GE-1025-00	00331	57%	27° / 35°	90%	2mm	0.45 lb-F
	10-36°	AC-GE-1036-00	00333	38%	27° / 43°			
	10-60°	AC-GE-1060-00	03259	25%	25° / 70°			
84mm	10-36°	AC-E-GE-1036-00	01595	30%	27° / 43°		3.1mm	
	10-60°	AC-E-GE-1060-00	03261	20%	20° / 70°			

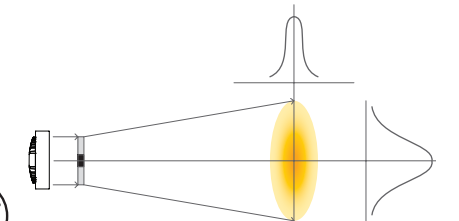

Flat Top

Provides even illumination center to edge. Eliminates video camera saturation, for use in applications such as critical video surveillance.

Diameter	Beam	Part Number	Product Code	CBCP of 10° Beam	Field Angle Horiz/Vert	Lumen Transmission	Thickness	Magnetic Attach Force
50mm	25x25°	AC-FR-2525-00	00335	19%	44° / 44°	90%	2mm	0.45 lb-F
	36x36°	AC-FR-3636-00	00337	14%	46° / 46°			
84mm	36x36°	AC-E-FR-3636-00	01597	14%	46° / 46°			

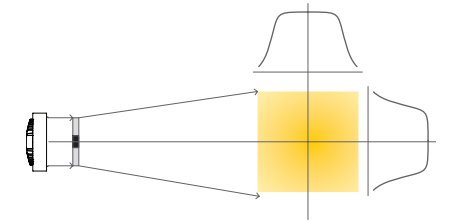

Louver

Eliminates high angle glare, making light beams disappear in downlight applications. Reduces angular intensity to 0.1% of peak at 40° full angle. Fits around luminaire face. Can be used in combination with Soraa Arc Accessories.

Diameter	Cutoff Angle	Part Number	Product Code	CBCP of 10° Beam	Thickness	Magnetic Attach Force
51.1mm	40°	AC-LU-4040-00	00339	63%	9mm	0.45 lb-F
84mm	40°	AC-E-LU-4040-00	01151	63%		

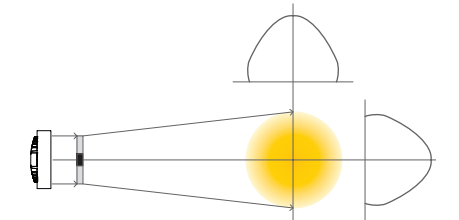

SORAA snap system™

Aim

Comprising two lenses, the Aim Snap bends the beam from 0° to maximum deflection angle of 20° while maintaining uniform and consistent colour and shape.

Diameter	Part Number	Product Code	Lumen Transmission	Beam	Maximum Deflection	Thickness	Magnetic Attach Force
50mm	AC-AM-0020-00	03255	85%	13°	20°	4mm	0.45 lb-F
84mm	AC-E-AM-0020-00	03257	85%	13°	20°	6.2mm	

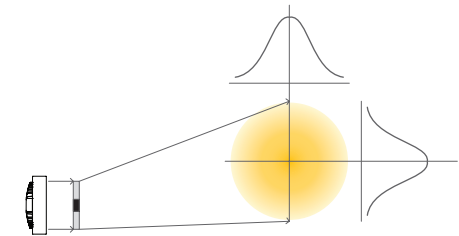

Stacked orientation lines will result in undesirable optical artifacts. Rotate one lens slightly to mitigate.



Wider angle between orientation lines produces less deflection.



Narrower angle between orientation lines produces more deflection.

How Aim Works

Use the orientation lines to adjust beam deflection angle.

CCT Shifter

Use in hospitality and restaurant applications to simulate warm dimming. Create custom colours for festive occasions or brand identity. A single luminaire SKU can be used for many different colour temperatures.

Diameter	CTO	Part Number	Product Code	Lumen Transmission	Mired Shift	Thickness	Magnetic Attach Force
50mm	1/4	AC-CC-0001-00	00323	90%	37	2mm	0.45 lb-F
	1/2	AC-CC-0002-00	00321	75%	83		
	3/4	AC-CC-0003-00	00319	60%	120		
84mm	1/4	AC-E-CC-0001-00	01153	90%	37	3.1mm	
	1/2	AC-E-CC-0002-00	01155	75%	83		
	3/4	AC-E-CC-0002-00	01157	60%	120		



CTO
1/4



CTO
1/2



CTO
3/4

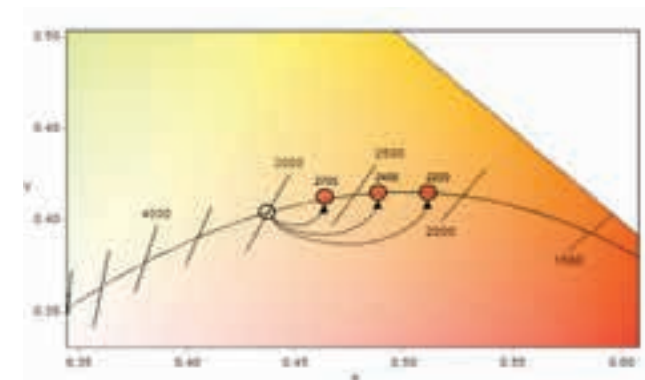

CCT Shift Effect

Starting CCT	1/4 CTO	1/2 CTO	3/4 CTO
2,700K	2,450K	2,200K	2,000K
3,000K	2,700K	2,400K	2,200K
4,000K	3,500K	3,000K	2,700K

COLOUR & WHITENESS

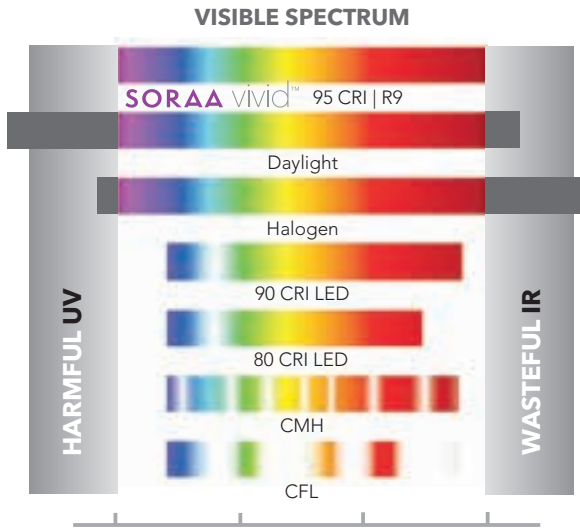

Soraa has engineered the perfect balance between colour rendering and white rendering. Soraa's core technology uses a violet LED emitter as the basis for full spectrum light. This allows both Vivid™ colour rendering and Natural White™ white rendering, which creates whiteness by exciting fluorescing agents with violet radiation, without the harmful effect of UV.

Rf: The TM-30 metric for colour fidelity (similarity to colours under natural light), a more accurate version of the CRI Ra. Rf is 100 for natural light.

Rg: The TM-30 metric for colour gamut (whether colours are more saturated than under natural light). Rg is 100 for natural light.

Rfh1: The TM-30 metric for colour fidelity for red tones. Rfh1 is a more accurate version of the CRI R9. Rfh1 is 100 for natural light.

Rw: The Soraa-developed metric for white fidelity. Rw measures the magnitude of excitation of whitening agents within white materials. Rw is 100 for natural light.

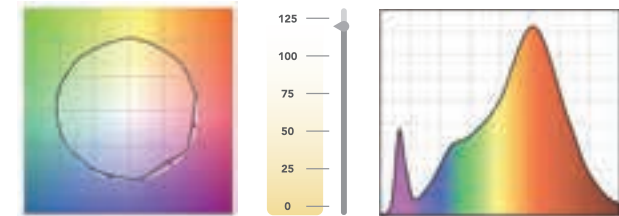

Rf: 90, Rg: 100, Rfh1: 95

Soraa Arc 2700K

CRI	R9	Rf
95	95	90

Rw: 120

CRI: 95, R9: 95

Rg	Rfh1	Rw	McA
100	95	120	3

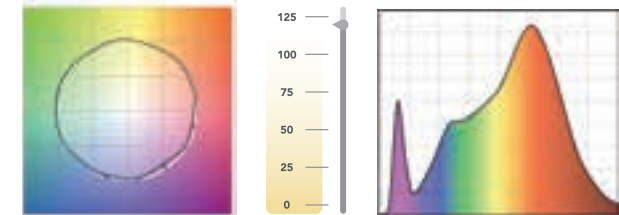

Rf: 90, Rg: 100, Rfh1: 95

Soraa Arc 3000K

CRI	R9	Rf
95	95	90

Rw: 120

CRI: 95, R9: 95

Rg	Rfh1	Rw	McA
100	95	120	3

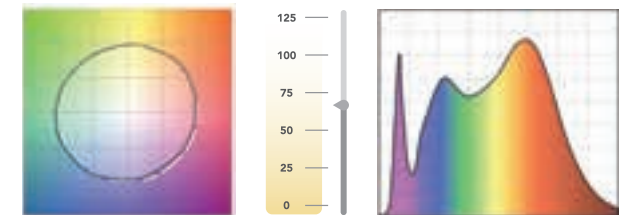

Rf: 90, Rg: 100, Rfh1: 95

Soraa Arc 4000K

CRI	R9	Rf
95	95	90

Rw: 70

CRI: 95, R9: 95

Rg	Rfh1	Rw	McA
100	95	70	3

SORAA arc™ | SPECIFICATIONS

Soraa VIVID™ LED

Soraa Full Spectrum integral LED Light Engine available in 2700K, 3000K, and 4000K with 95 CRI and 95 R9. IR and UV free.

Soraa Optics

Soraa optic technology with exceptional beam control and smooth uniform light distribution. The 9°, 10°, and 15° beam versions are compatible with Soraa SNAP accessories.

Construction and Finish

Light engine is made of die cast aluminium, transformer case from extruded aluminum. Durable satin finish. Custom colours available.

Electrical

220-240VAC fully integral LED electronic constant current driver.

Frequency: 50/60Hz

Power Factor: 0.93

Wattage: 11W, 18W, 20W

Dimming and Flicker

Dimmable to <1%

Percent Flicker: < 30%

Triac and ELV dimming standard

Refer to website for details

Applications

Suitable for damp or dry locations. For interior use only.

Accessories

Luminaires can accommodate both Soraa Arc accessories and Soraa SNAP simultaneously.

Compliance

cULus Listed. FCC CFR Title 47 Part 15 Class B compliant.

Warranty

Five year warranty. Consult www.soraa.com.

Operating Temperature

Minimum -40° C, 25° C typical.



Soraa Arc Photometrics

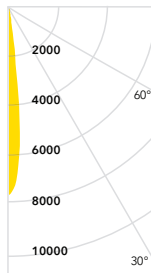

50mm
Narrow Spot
10°

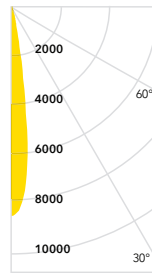

50mm
Spot
15°

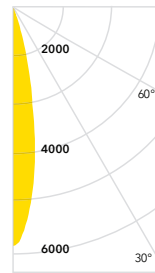

50mm
Narrow Flood
25°

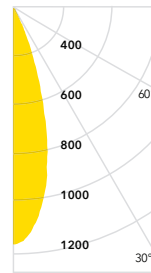

50mm
Flood
36°

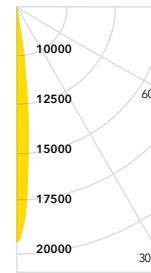

100mm
Narrow Spot
9°

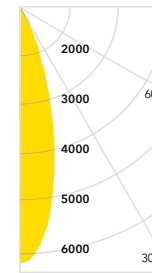

100mm
Narrow Flood
25°

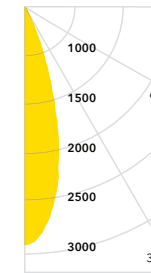

100mm
Flood
36°

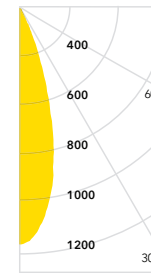

100mm
Wide Flood
60°

SIMPLY PERFECT LIGHT.

SORAA[®]



**SORAA
CORPORATE HEADQUARTERS**

6500 Kaiser Dr. Suite 110
Fremont, CA 94555

SORAA INTERNATIONAL

Unit 1, Chelsing House
Mead Lane
Hertford
SG13 7AW
United Kingdom
Phone: +44 (0)1992 535053

JAPAN

3-22-4-203 Funado
Itabashi-ku
Tokyo, 174-0041
Japan
Phone: +81 (0)3 5948 7440

GENERAL INFO

North America info@soraa.com
International international@soraa.com
Japan japan@soraa.com
Soraa Arc product info:
quotes@soraa.com

TECH SUPPORT

Phone: +44 1992 535 053
techsupport@soraa.com



SORAA arc™

visit us: www.soraa.com

follow us:   

© COPYRIGHT 2017 — REV #01
Soraa is a registered trademark of Soraa, Inc.
Soraa Arc is a trademark of Soraa, Inc.